

## Technical Note 113

# Comparing the dynamic ranges of spectrum analyzers and radio receivers—Part 2

Whether part of your instrument pool or a new acquisition, one of the main criteria by which spectrum analyzers and radio receivers are judged is their dynamic range. It plays a significant role, both in deciding what to purchase and in making error-free measurements. This Technical Note explains dynamic range for beginners and advanced users and tells you what you need to bear in mind when making comparisons.

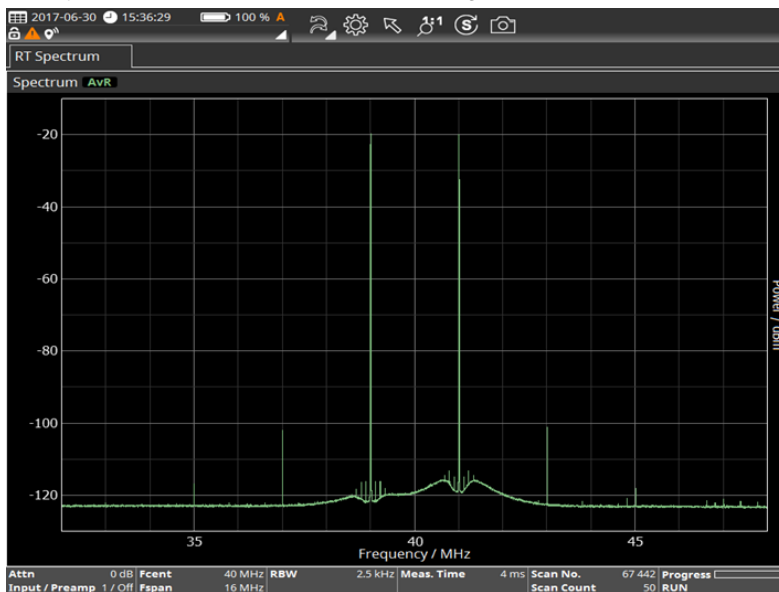

Figure 1: Narda SignalShark

## Contents

### Part 1: Technical Note 112

1	What is dynamic range? .....	Page	2
---	------------------------------	------	---

### Part 2: Technical Note 113

2	How to compare dynamic ranges .....	Page	2
3	Dynamic range from the ITU viewpoint.....	Page	6
4	The high dynamic range (HDR) of the Narda SignalShark .	Page	9
5	Measures to improve the dynamic range.....	Page	12
6	Conclusions .....	Page	14
7	References .....	Page	16

By: Mark Reinhard

© September 2017

Narda Safety Test Solutions GmbH

Sandwiesenstr. 7

72793 Pfullingen, Germany

Tel.: +49 7121 9732-0

Fax: +49 7121 9732-790

[www.narda-sts.com](http://www.narda-sts.com)



If terms such as “low distortion mode”, “normal mode”, or “high sensitivity mode” are used instead of stating the input attenuation or the reference level, the parameters quoted for “normal mode” should be used preferably for comparison. The parameters for “high sensitivity mode” should only be used if you can be certain that an additional preamplifier was not used. Normally, the level of the intercept points drops progressively from “low distortion” through “normal” to “high sensitivity”.

The intercept points should usually be stated conservatively. In such cases, they will be quoted as guaranteed values (“≥”). However, they are also often quoted as typical values.

Many data sheets quote the test level used in addition to the intercept points, and also the frequency separation between the two signals if a dual tone scenario is the basis for the values. As we have seen, the intercept points are theoretical extrapolations. So, it is important to know the degree to which the system is driven in order to be able to calculate the intercept points. The closer the stated test levels and frequencies given in two different data sheets are to each other, the smaller the uncertainty in the comparison will be.

#### ***Specification of absolute levels of harmonics and intermodulation***

Sometimes manufacturers do not specify the intercept points. Instead, they quote the levels of the measured actual harmonics and intermodulation products. In such cases, you will have to work out the intercept points yourself (section 1.2. in Part 1 explains how to do this). Once again, it is important to know whether the measurements are based on a particular input attenuation value or what the reference level (linked to the input attenuation) setting was.

If only the levels of the harmonics are specified, but you are more interested in the intermodulation products, you can legitimately convert the specified single tone scenario into a dual tone scenario by adding 6 dB to the 2<sup>nd</sup> harmonics and 9.54 dB to the 3<sup>rd</sup> harmonics to get the intermodulation levels.

If the levels of the harmonics and intermodulation products are stated in dB $\mu$ V instead of dBm, they can be reduced by 107 dB to give the dBm values again (assuming a 50  $\Omega$  system).

The frequency ranges must also match. There is no point in determining and comparing the intercept points for frequency ranges that differ by several decades.

### *Sensitivity, DANL, NF*

As we have seen, the sensitivity is the second most important quantity alongside the intercept points for determining the intermodulation free dynamic range. The sensitivity of spectrum analyzers and receivers is usually specified in terms of the displayed average noise level (DANL). This is normally based on an RBW of 1 Hz and an averaging detector with an input attenuation of 0 dB. If input attenuation is used, this value must be subtracted from the DANL.

The sensitivity of RF receivers or RF equipment is often calculated, based on specific, fixed RBW settings or channel bandwidths. In such cases, the DANL can be calculated using equation 3 in Part 1, but this is a purely theoretical value that is more useful for comparison rather than being of any practical use.

If the noise coefficient (logarithm, in dB) or noise figure (NF, linear) is stated instead of the DANL, equation 4 can be used. The DANL is determined by adding the thermal noise, -174 dBm, to the NF.

There is little practical significance whether the DANL values given in the data sheet are quoted for a noise temperature of 26.85 °C (300 K) or 22 °C (295.15 K), since this only changes the sensitivity by about 0.1 dB. It is much more important that the DANL or NF are determined with the same settings as for IP2 and IP3. You must also be certain that any additional preamplifier is not activated. Although the use of a preamplifier can achieve considerably improved noise values, this is at the expense of an over-proportional degradation of the IP2 and IP3.

The DANL quoted in the data sheets for many hand held spectrum analyzers includes a systematic error of around 2.5 dB compared with the RMS value. This is because averaging over the noise level is assumed rather than averaging over the noise power. The DANL quoted for the Narda SignalShark and IDA/SRM products is always the RMS value, which allows direct conversion to the NF.

Once again, as with the intercept points, you will need to remember to check that the frequency ranges match when comparing sensitivity between data sheets.

### *IMFDR<sub>2</sub>, IMFDR<sub>3</sub>*

If the intercept points and the DANL of the two instruments you are comparing are known, you can use the equations 1 and 2 that were given in Part 1 to calculate the 2<sup>nd</sup> or 3<sup>rd</sup> order IMFDR. If you want to, you can

also determine the 2<sup>nd</sup> and 3<sup>rd</sup> order HFDR. The HFDR<sub>2</sub> is 3 dB greater than the IMFDR<sub>2</sub> and the HFDR<sub>3</sub> is 3.18 dB greater than the IMFDR<sub>3</sub>.

If the 2<sup>nd</sup> or 3<sup>rd</sup> order IMFDR is directly specified in a data sheet, the question of its whereabouts is raised. A large IMFDR does not necessarily mean that the system possesses both high sensitivity and high overmodulation immunity. If a measuring device that has a large IMFDR also has low sensitivity (i.e. a high DANL value), this means that it will have high immunity to overmodulation. Although this is a good thing, it must be seen in the context of the sensitivity requirements.

It is therefore useful to work back to the intercept points from the IMFDR. The DANL is, of course, required for this, as seen from equations 1 and 2.

Many data sheets quote intercept points for wide frequency ranges as well as the IMFDR for specific frequencies. In doing this, the manufacturers intend to give particularly detailed information for specific scenarios (frequencies, signal levels). In such cases, it is a good idea to carry out an internal comparison for the data sheet by determining all the dynamic range parameters for the wide frequency ranges referred to by the intercept points and for the specific frequencies referred to by the IMFDR values. As we have already explained above, the intercept points are often quoted as guaranteed values for wide frequency ranges and can improve dramatically at certain frequencies.

### 3 Dynamic range from the ITU viewpoint

As well as specifying measurement methods for IP3, NF, and so on, the ITU recommends specific values. In the ITU Handbook for Spectrum Monitoring, these values refer to monitoring receivers or directional RF receivers rather than to spectrum analyzers in general. These values are given in the table below.

Parameter	ITU recommendation
IP2/SOI in the frequency range > 3 MHz to < 30 MHz	60 dBm
IP2/SOI in the frequency range $\geq$ 30 MHz to $\leq$ 3 GHz	40 dBm
IP3/TOI in the frequency range > 3 MHz to < 30 MHz	20 dBm
IP3/TOI in the frequency range $\geq$ 30 MHz to $\leq$ 3 GHz	10 dBm
NF in the frequency range > 2 MHz to < 20 MHz	15 dB
NF in the frequency range $\geq$ 20 MHz to $\leq$ 3 GHz	12 dB

**Table 3: Dynamic range parameters as per the ITU recommendation, as a table, absolute**

In specifying these values, the ITU handbook refers back to the measurement methods that are described in the two following Recommendations in particular:

- ITU-R SM.1837-1: Test procedure for measuring the 3rd order intercept point (IP3) level of radio monitoring receivers (August 2013)
- ITU-R SM.1838: Test procedure for measuring the noise figure of radio monitoring receivers (December 2007)

Graphical methods of comparison can be useful in addition to the simple comparison of numerical values from a table. Figure 2 shows a triangular diagram that can be used as a reference for further comparisons. The sensitivity (DANL), IP2, and IP3 values are the three corners of the triangle in figure 2. The values used for the blue triangle correspond to the ITU specifications for the higher of the two frequency ranges given in Table 3. The triangle is thus based on a noise figure of 12 dB, an IP2 at 40 dBm and an IP3 at 10 dBm. These figures are not absolute, however, but relative. The triangle thus represents the difference from the ITU requirements. The diagram is defined in such a way that the triangle increases in size as the specifications improve. The DANL is usually quoted in data sheets as a guaranteed value, while IP2 and IP3 are generally given as typical values. For this reason, the following diagrams are based on precisely these values.

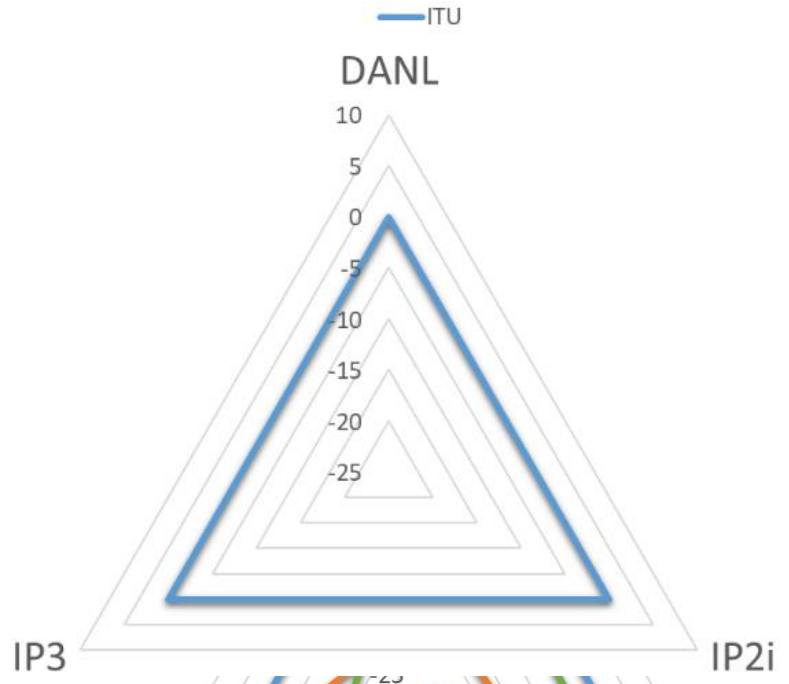

Figure 2: ITU recommended dynamic range parameters as a relative graph

Figure 3 includes the same parameters of the SignalShark for comparison. In the corresponding frequency range, the SignalShark's NF is 15 dB. This is 3 dB higher than the ITU recommendation, so it appears as a smaller value in the triangle. The value for IP2 above 630 MHz exactly matches the ITU recommendation, and the IP3 is 2 dB better than the ITU recommendation. As a result, the triangle for the SignalShark above 630 MHz matches the ITU triangle almost exactly.

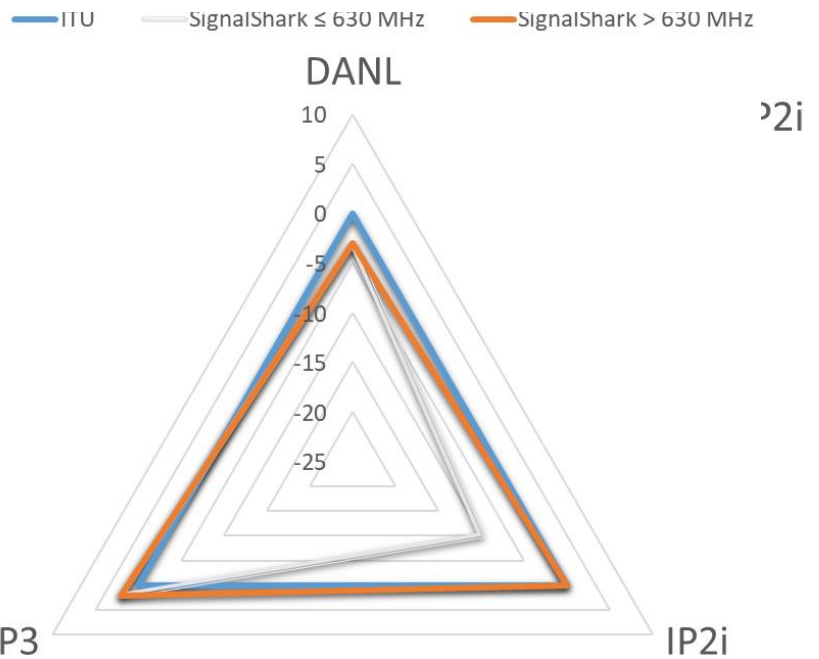
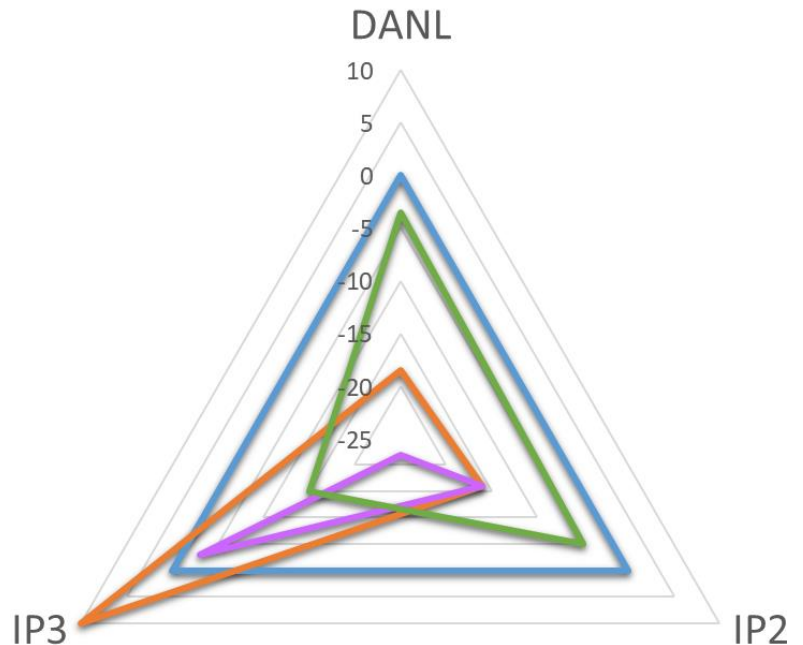

Figure 23: SignalShark dynamic range parameters compared with the ITU recommendations

Whereas figure 3 shows that the Narda SignalShark almost completely fulfils the ITU specifications, figure 4 shows a different picture. The values relevant to dynamic range for very popular spectrum analyzers and receivers of similar size and shape to the SignalShark (i.e. handheld devices) have been plotted in this diagram.

Whereas figure 3 shows that the Narda SignalShark almost completely fulfils the ITU

specifications, figure 4 shows a different picture. This diagram shows the values relevant to dynamic range for very popular spectrum analyzers and receivers of similar size and shape to the SignalShark (i.e. handheld devices). It clearly illustrates very different attributes. For example, the green trace indicates a sensitivity that is around 3.5 dB lower (i.e. worse), with about 5 dB lower IP2 and 15 dB lower IP3 (i.e. worse values again). While the green trace represents a handheld *receiver*, the orange and violet traces represent handheld *spectrum analyzers*. Compared to the green trace, they both show better IP3 values, but worse IP2 and NF values. Even though the orange trace beats the ITU specification for IP3 by some 10 dB, none of the triangles in figure 24 fill the specification to the same extent as the similarly sized SignalShark does in figure 3.



**Figure 4: Specifications of Anritsu MS2720T (orange), R&S FSH (violet), R&S PR100/DDF007 (green)**

While figure 4 looked at handheld measuring devices, figure 5 compares a high performance, yet economical, compact radio direction finding system with the criteria recommended by the ITU. The trace has been plotted for two system modes, namely: “low distortion” and “normal”. In both cases it is easy to see that much more of the ITU triangle is filled compared to the diagram in figure 4. Nevertheless, neither of the traces in figure 5 reach the sensitivity requirement of the ITU recommendation. The IP2 and IP3 requirements are only met or exceeded in “low distortion” mode. But, it should be said, this is for a RF direction finding system that is much larger, heavier, and more expensive.

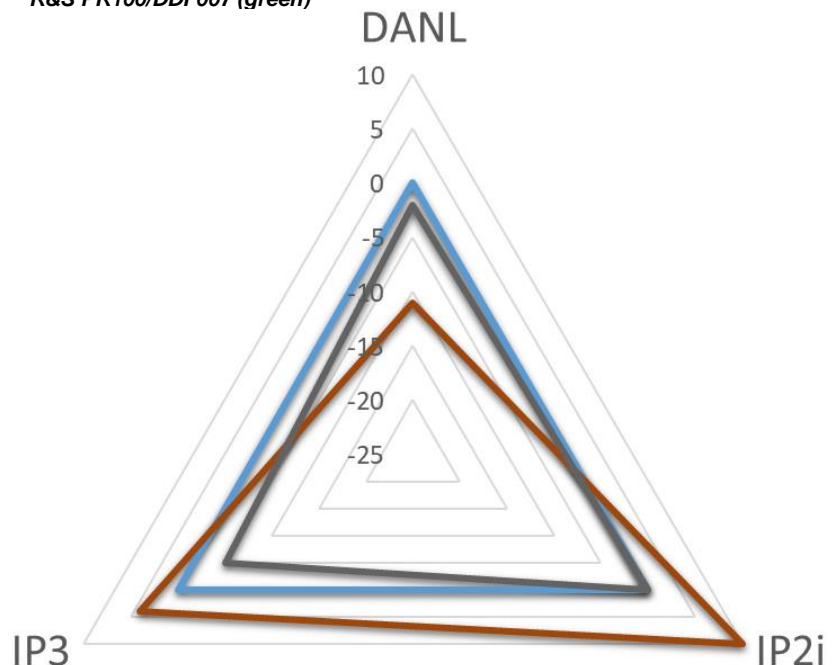

**Figure 25: Specification of R&S EB500 low distortion mode (brown), normal mode (gray)**

To conclude section 3, we should stress that the ITU provides important information in its Spectrum Monitoring Handbook and its recommendations for characterizing measuring devices. Diagrams such as those shown in figures 3 through 5 are very useful for making a quick comparison.



## 4 The high dynamic range (HDR) of the Narda SignalShark

Section 3 explained that the SignalShark achieves impressive dynamic range parameters, despite being a compact handheld device. The reason for this is not because of any single component in the signal processing path but is rather the product of practically all the components and the overall concept of the signal processing from the RF front end through to the analog to digital converter. The active RF components in the SignalShark are low noise, and they are linear over a wide drive range. The SignalShark also has a preselector in the form of a sub octave filter bank. This in particular suppresses the 2<sup>nd</sup> order harmonics very early on in the signal processing chain and makes it possible to achieve the IP2 requirements of the ITU. A simplified block RF circuit diagram of the SignalShark is shown in figure 6.

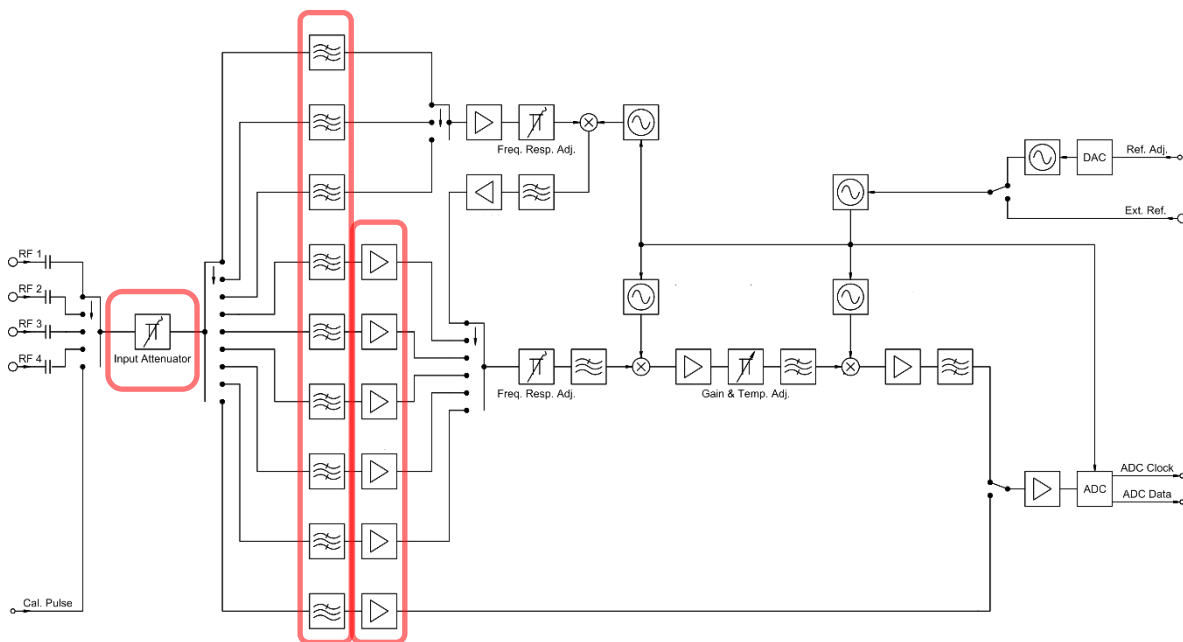

**Figure 6: High-performance RF front end of the SignalShark—high dynamic range due to suboctave filter bank (center), high quality IF amplifier (right) and attenuators that cover all frequency paths.**

At the start of the signal processing path, the SignalShark is equipped with an attenuator module that can be set in 0.5 dB steps up to a value of 25 dB. This applies to all the frequency paths, i.e. to the entire frequency range of the SignalShark (8 kHz to 8 GHz).

This enables the SignalShark to achieve the dynamic range parameters shown in Table 2 below, which we have already seen visualized for the frequency range 30 MHz to 3 GHz as a triangle in section 3.

Parameter	Narda SignalShark	ITU recommendation
IP2/SOI in the frequency range > 3 MHz to < 30 MHz	> 56 dBm	60 dBm
IP2/SOI in the frequency range $\geq$ 30 MHz to $\leq$ 630 GHz	30 dBm	40 dBm
IP2/SOI in the frequency range > 630 MHz to $\leq$ 3 GHz	40 dBm	40 dBm
IP3/TOI in the frequency range > 3 MHz to < 30 MHz	> 20 dBm	20 dBm
IP3/TOI in the frequency range $\geq$ 30 MHz to $\leq$ 3 GHz	12 dBm	10 dBm
NF in the frequency range > 2 MHz to < 20 MHz	14 dB	15 dB
NF in the frequency range $\geq$ 20 MHz to $\leq$ 3 GHz	15 dB	12 dB

**Table 2: Narda SignalShark dynamic range parameters**

Based on an actual SignalShark dynamic range characterization measurement, figure 7 shows the harmonics and intermodulation products that arise. The drive signals applied in this case are at frequencies of 19 MHz and 20 MHz and have a level of -25 dBm. The resulting 2<sup>nd</sup> order intermodulation products are at -133 dBm, with the 3<sup>rd</sup> order intermodulation at -117 dBm. If we now calculate the IP2 and IP3 from these values, we get an IP2 of 83 dBm and an IP3 of 21 dBm. Both these values are better than those quoted in the SignalShark data sheet. The noise floor in this instance is at -160 dBm, which can be derived or measured from the noise figure of 14 dB and an RBW of 1 Hz.

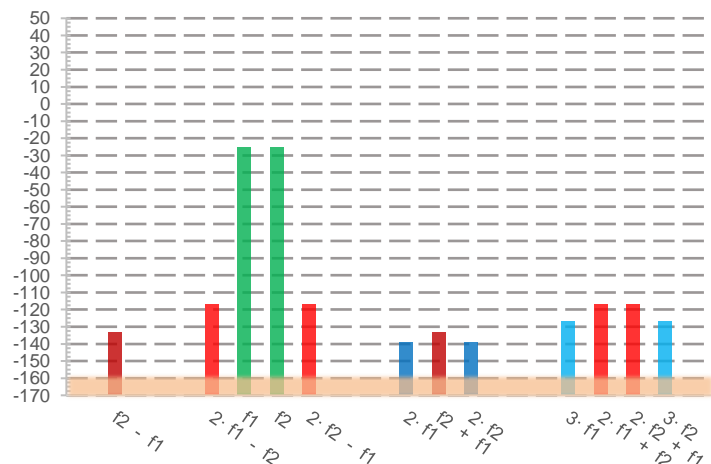
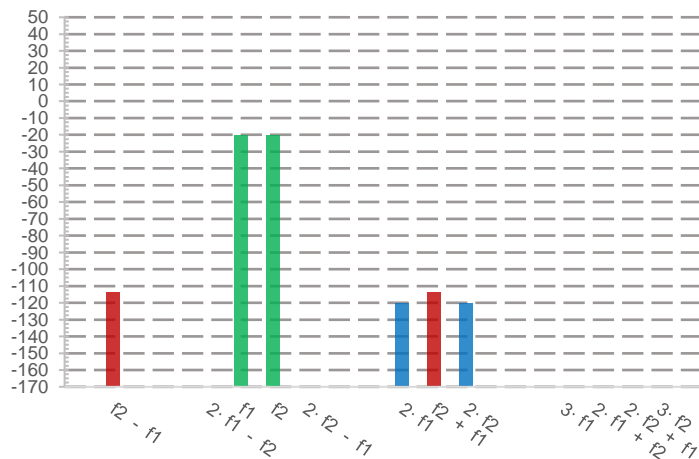

**Figure 7: SignalShark dynamic range for -25 dBm signals at 19 MHz and 20 MHz**

Only the 2<sup>nd</sup> order intermodulation is of interest in figure 8. Here, two signals are input at frequencies of 890 MHz and 2150 MHz at a level of -20 dBm each. The ensuing 2<sup>nd</sup> order intermodulation is measured at -114 dBm. This gives an extrapolated value of 74 dBm for the IP2. It may seem astonishing that two frequencies that are so far apart can be used to determine the IP2, but this situation is not at all unusual in practice. For example, in ITU Region 1 GSM/2G signals are present around 900 MHz and UMTS/3G signals at around 2100 MHz. If these two ranges intermodulate, the multiples will occur at around 3040 MHz and 1260 MHz. Many satellite communications applications (Iridium, Inmarsat, Thuraya, GPS, Galileo, Glonass) use the frequency range from 1 GHz to 2 GHz (L band). So, a high immunity to GSM and UMTS downlink signals is particularly advantageous when searching for interference in this frequency range. Thus, characterization of the dynamic range is also justified at these frequencies and shows that the SignalShark once again exceeds the guaranteed IP2 value of 40 dBm specified in the data sheet.

In the final example, let us concentrate on a dual tone scenario with two -30 dBm signals at 928 MHz and 929 MHz respectively (figure 29). The measured 2<sup>nd</sup> order intermodulation is at -118 dBm, while the measured 3<sup>rd</sup> order intermodulation is at -125 dBm. After extrapolation, this gives an IP2 of 65 dBm and an IP3 of 14 dBm.

Thus, for the SignalShark, the tendency becomes apparent that the IP2 value can be not just a few dB but several dozen dB above the value of 60 dBm or 20 dBm. Meanwhile, the IP3 value behaves differently, even so in the above examples being usually only a few dB above the specified value of 20 dBm or 10 dBm.



**Figure 8: SignalShark dynamic range for -20 dBm signals at 890 MHz and 2150 MHz**

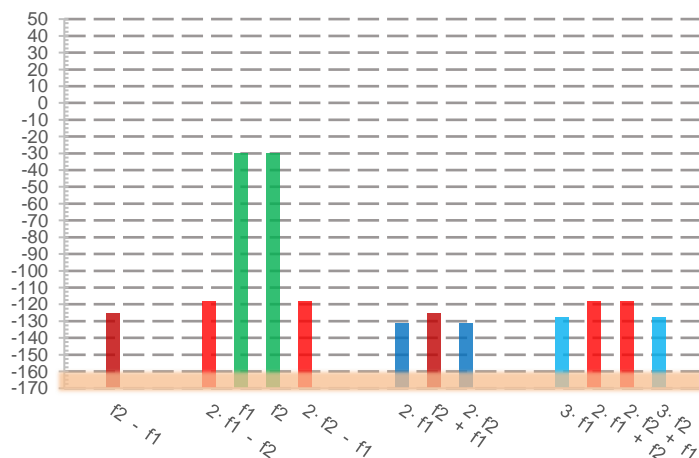

**Figure 9: SignalShark dynamic range for -30 dBm signals at 928 MHz and 929 MHz**

## 5 Measures to improve the dynamic range

This section gives a concise summary of the measures that can be taken in order to increase the dynamic range. The dynamic range in this context is always the IMFDR, and the measures range from the RF front end design through to the measurement application itself.

### *RF front end design*

As already explained in section 4, high quality RF components (mixers, IF amplifiers) and preselection filters that have a wide linear operating range are an important basis for a wide dynamic range in any spectrum analyzer or receiver. In the case of integrated preselection filters, a distinction is made between sub-octave filters and tracking filters. For high efficiency, the latter normally take up much more space and increase the system power consumption.

### *Preamplifiers*

Preamplifiers are very popular for further reducing the noise floor. They offer advantages for very sensitive measurements but can prove a disadvantage in situations where strong signals are present that can drive the measuring device close to or even into saturation. Preamplifiers should therefore always be used with caution.

### *External filters*

External filters are basically the same as preselection filters in that they allow a certain frequency range to pass through (bandpass) or attenuate this range considerably (band stop). External filters are therefore dimensioned to handle specific frequency ranges. To achieve attenuation values of typically 90 dB, these filters can reach a significant, but still portable, size. Figure 10 and Table 3 show some of the filters offered in the Narda filter range.

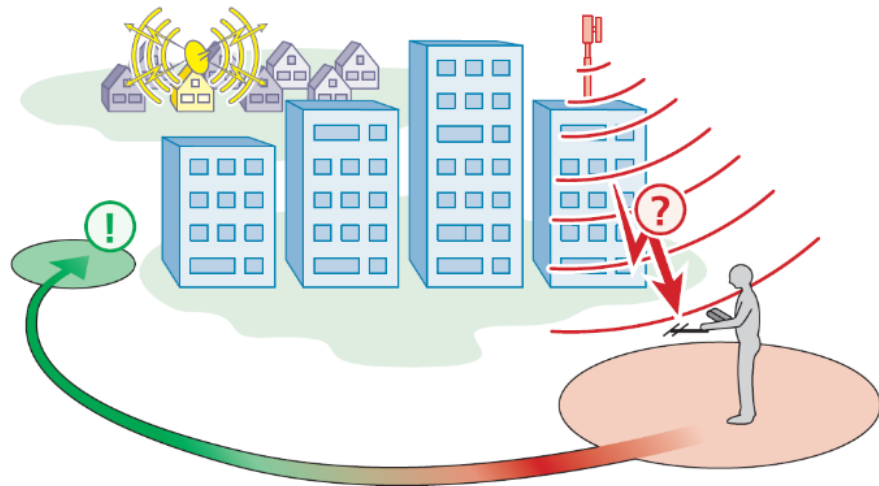

**Figure 10: External filter between antenna and receiver**

Filter type	Frequency band	Application
Bandpass	108 – 144 MHz	Air traffic control
Bandpass	1710 – 1785 MHz	E-UTRA bands 3, 4, 9, 10; GSM-1800; LTE-1800
Bandpass	1880 – 1900 MHz	DECT ITU region 1, Europe, South Africa, Hong Kong
Band stop	791 – 821 MHz	E-UTRA band 20 (downlink), LTE-800
Band stop	1805 – 1880 MHz	E-UTRA band 3 (downlink), GSM-1800, LTE-1800

**Table 3: Extract from the Narda STS External Filters data sheet**

The previous sections have concentrated on optimizing the dynamic range by means of additional hardware. However, this is often not possible or practicable. But there is still a possible solution in a change in the measurement strategy. Figure 11 makes it clear that the surrounding infrastructure does not always have to be a disadvantage but can even be helpful when hunting for cellular phone interference, for example. The nearby base station in figure 11 is making it difficult to analyze the signal being searched for that is emanating from a source in the background, because it is driving the measuring device at a high level. The attenuation caused by the buildings can be utilized to suppress the unwanted downlink signals simply by changing the location of the measurement. At the same time, there is a chance that the signal to noise ratio of the wanted signal can also be increased.



**Figure 11: Changing the measurement location to avoid strong downlink signals**

Many ideas and tricks have been developed for the task of hunting for mobile radio interference, which will not be discussed here. These generally are based on the fact that measuring devices with very restricted dynamic ranges are being used. So, this section 5 ends with the conclusion that we need to pay very close attention to the measurement applications and the associated requirements and challenges when acquiring new measuring devices.

## 6 Conclusions

The most important technical relationships that we have developed in this Technical Note are summarized in conclusion in this section.

### *IMFDR and ITU*

- The dynamic range of a spectrum analyzer or receiver is usually understood to be the intermodulation free dynamic range (IMFDR), which is at least defined by IP2, IP3 and DANL. It is important that all three parameters are determined at the same device settings.
- The dynamic range is a relative quantity and does not as such define the absolute sensitivity or the absolute intercept points of a measuring device.
- The IMFDR can increase or decrease depending on the sensitivity settings and the input attenuation.
- The dynamic range can be increased by means of preselection filters (preferably sub-octave filters), preamplifiers, a lower RBW, higher input attenuation, high quality RF components that have a wide linearity, and in a wider sense by changing the measurement strategy.
- The ITU recommends measurement methods for dynamic range characterization and concrete values for IP2, IP3, and NF.

### *Unwanted artifacts, harmonics, and intermodulation*

- A distinction must always be made regarding the type of unwanted artifact between harmonics, intermodulation, and spurious signals (input related / residual).
- 2<sup>nd</sup> order harmonics and intermodulation rise by 2 dB when the wanted signal driving the device is increased by 1 dB.
- 3<sup>rd</sup> order harmonics and intermodulation rise by 3 dB when the wanted signal driving the device is increased by 1 dB.
- The 2<sup>nd</sup> order harmonics in a dual tone scenario are 6 dB below the 2<sup>nd</sup> order intermodulation.
- The 3<sup>rd</sup> order harmonics in a dual tone scenario are 9.54 dB below the 3<sup>rd</sup> order intermodulation.

### *Intercept points IP2, IP3*

- The intercept point is the power value at which the unwanted artifact is exactly the same strength as the wanted signal.
- Intercept points can be determined for 2<sup>nd</sup> or higher order harmonics and intermodulation.
- IP2/SOI and SHI are interrelated: The SHI is 6 dB above the IP2/SOI.
- IP3/TOI and THI are interrelated: The THI is 4.77 dB above the IP3/TOI.
- The intercept points depend on the input attenuation: If the input attenuation is increased by 5 dB, all the intercept points will rise by 5 dB. The input attenuation and the reference level are often coupled together, so it is important to make the correct conversion when making comparisons.

### *Sensitivity, DANL, NF*

- The sensitivity is specified by the noise figure (NF) or noise power (displayed average noise level, DANL). It is the complement of the intercept points for the determination of the IMFDR.
- The DANL primarily depends on the RBW, the NF, Boltzmann's constant, and the temperature.

## 7 References

Based on this Guide, readers should also refer to the following documents, which can be found on our Internet site under the product “Interference and Direction Analyzer IDA 2” and “Product literature”:

- Technical Note 110: “Using external filters to maintain measurement sensitivity in highly dynamic measurement environments”
- Technical Note 104: “Maximizing dynamic range by optimizing the input attenuator setting”

Also take a look at our product pages on the Internet:

Monitoring Receiver and Real Time Handheld Analyzer SignalShark:

<https://www.narda-sts.com/de/signalshark/>

Interference and Direction Analyzer IDA 2:

<https://www.narda-sts.com/de/spektrum-und-real-time-spektrum-analyzer/ida-2/>

Narda Remote Spectrum Analyzer & Monitoring Receiver NRA 6000 RX:

<https://www.narda-sts.com/de/monitoring-receiver/nra-6000-rx/>

External filters (data sheet):

[https://www.narda-sts.com/de/spektrum-und-real-time-spektrum-analyzer/ida-2/?elD=mpNardaProducts\\_Downloads&tx\\_mpnardaproducts\\_download%5BcontentElement%5D=12560&tx\\_mpnarda\\_products\\_download%5BfileReference%5D=2507&cHash=faa1d20d1ea349d1187bfc79ecd21e86](https://www.narda-sts.com/de/spektrum-und-real-time-spektrum-analyzer/ida-2/?elD=mpNardaProducts_Downloads&tx_mpnardaproducts_download%5BcontentElement%5D=12560&tx_mpnarda_products_download%5BfileReference%5D=2507&cHash=faa1d20d1ea349d1187bfc79ecd21e86)

Find us on YouTube under:

<https://www.youtube.com/channel/UCxerYxUbG0bYG5pfONhSHNQ>

or search for “Narda Safety Test Solutions”

**Narda Safety Test Solutions GmbH**  
Sandwiesenstrasse 7  
72793 Pfullingen, Germany  
Phone: +49 (0) 7121-97 32-0  
Fax: +49 (0) 7121-97 32-790  
E-mail: [info@narda-sts.com](mailto:info@narda-sts.com)  
[www.narda-sts.com](http://www.narda-sts.com)

**Narda Safety Test Solutions**  
435 Moreland Road  
Hauppauge, NY 11788, USA  
Phone: +1 631 231-1700  
Fax: +1 631 231-1711  
E-Mail: [info@narda-sts.com](mailto:info@narda-sts.com)

**Narda Safety Test Solutions GmbH**  
Beijing Representative Office  
Xiyuan Hotel, No. 1 Sanlihe Road,  
Haidian  
100044 Beijing, China  
Phone +86 10 6830 5870  
[support@narda-sts.cn](mailto:support@narda-sts.cn)

© The name and logo are registered trademarks of Narda Safety Test Solutions GmbH – Trade names are the trademarks of their owners.